

M25x1,5
Kabelanschluss
gland metric
raccord de câbles

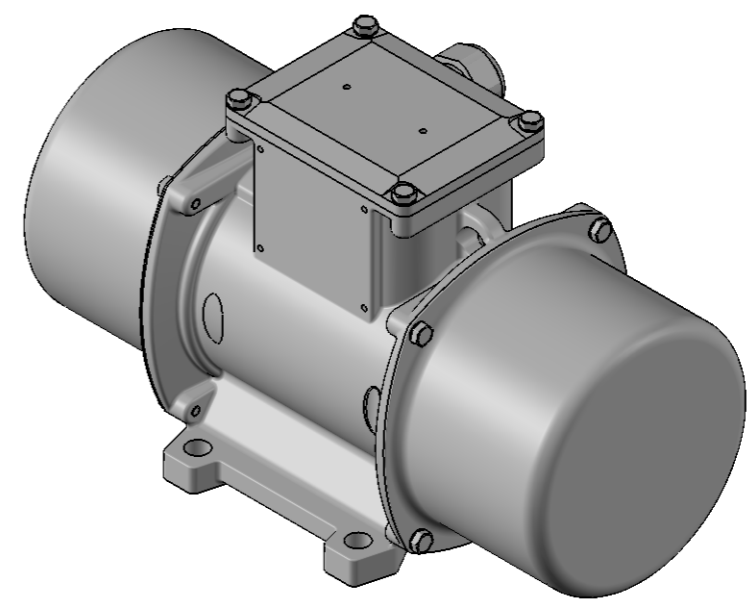
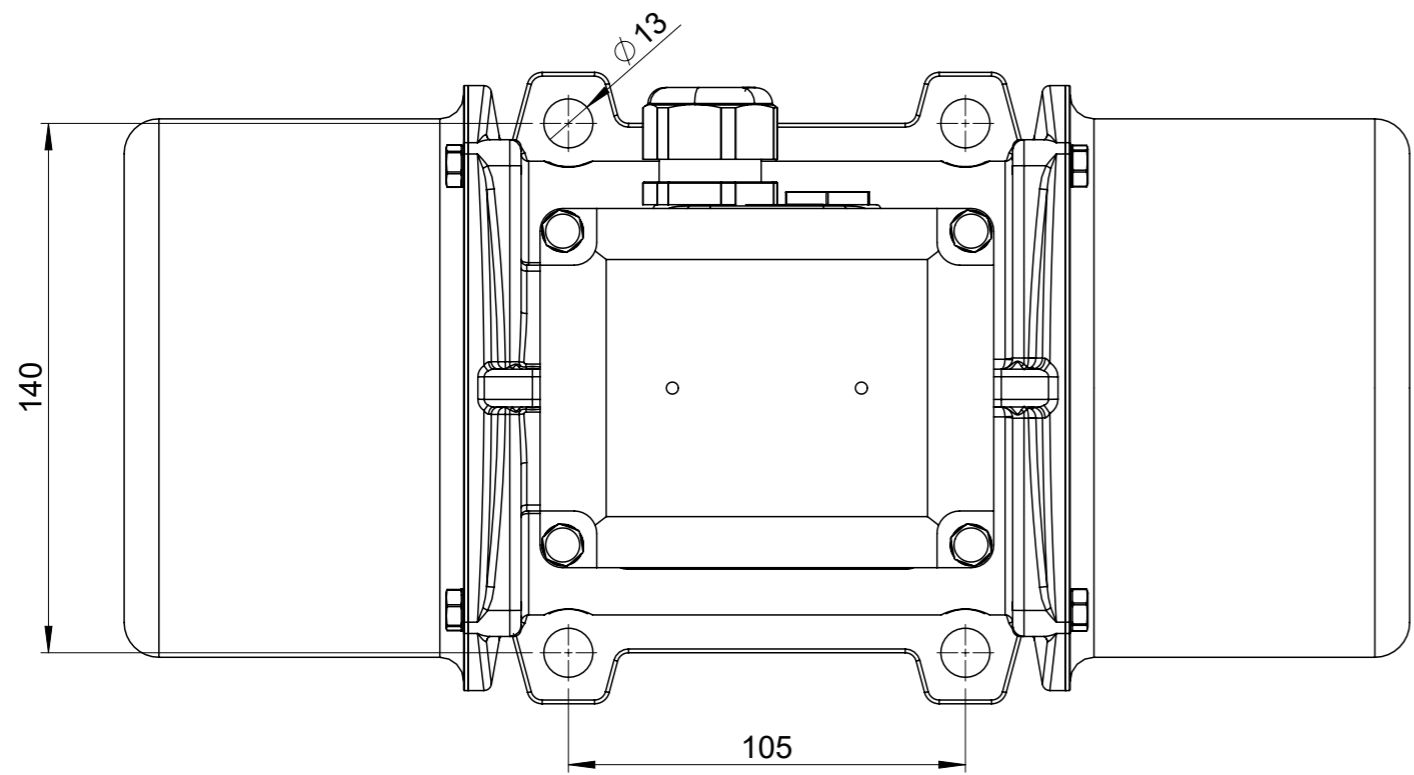
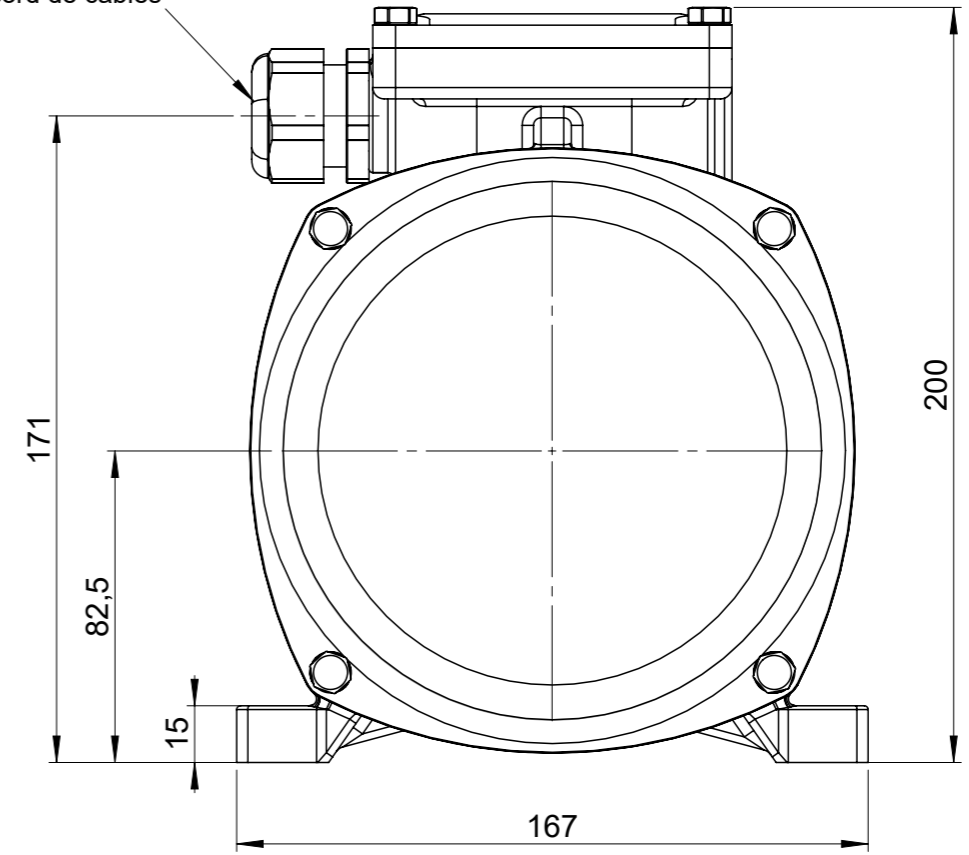

alle Schutzrechte vorbehalten
all rights reserved
tous droits réservés

Datum: / Date: / Date:
17.01.2019

Angebot Nr.: / Quotation no.: / Offre no.:

Bestell Nr.: / Part no.: / No d'article:
03042000

NES 16190
Elektro-Außenvibrator
Electric External Vibrator
Vibrateur électrique externe

NetterVibration 
Fritz-Ullmann-Straße 9, 55252 Mainz-Kastel
Tel.: +49 6134 2901-0, www.NetterVibration.com